



LED NUMERIC DISPLAY, 2 DIGIT
BL-D50X-21
Absolute maximum ratings (Ta=25°C)

Parameter	S	D	UR	E	Y	G	Unit
Forward Current I_F	25	25	25	25	25	30	mA
Power Dissipation P_d	60	60	60	60	60	65	mW
Reverse Voltage V_R	5	5	5	5	5	5	V
Peak Forward Current I_{PF} (Duty 1/10 @1KHZ)	150	150	150	150	150	150	mA
Operation Temperature T_{OPR}	-40 to +80						°C
Storage Temperature T_{STG}	-40 to +85						°C
Lead Soldering Temperature T_{SOL}	Max.260±5°C for 3 sec Max. (1.6mm from the base of the epoxy bulb)						°C

Absolute maximum ratings (Ta=25°C)

Parameter	UHR	UE	YO	UY	UG	PG	UB	UW	Unit
Forward Current I_F	30	30	30	30	30	30	30	30	mA
Power Dissipation P_d	75	65	65	65	75	110	120	120	mW
Reverse Voltage V_R	5	5	5	5	5	5	5	5	V
Peak Forward Current I_{PF} (Duty 1/10 @1KHZ)	150	150	150	150	150	150	100	100	mA
Operation Temperature T_{OPR}	-40 to +80								°C
Storage Temperature T_{STG}	-40 to +85								°C
Lead Soldering Temperature T_{SOL}	Max.260±5°C for 3 sec Max. (1.6mm from the base of the epoxy bulb)								°C

LED NUMERIC DISPLAY, 2 DIGIT

BL-D50X-21

Package configuration & Internal circuit diagram

BL-D50X-21 Series

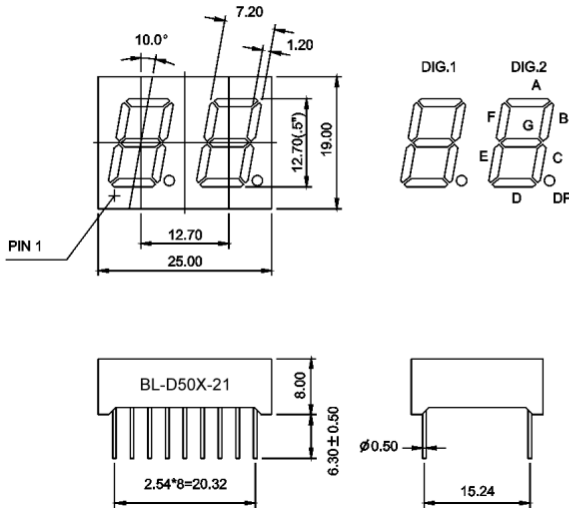

BL-D50G-21

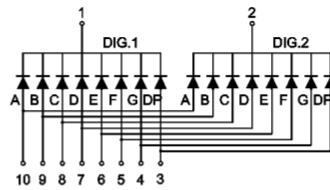

BL-D50H-21

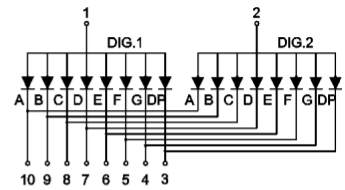

BL-D50I-21

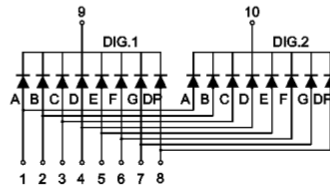

BL-D50J-21

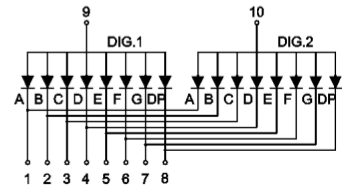

Notes:

1. All dimensions are in millimeters (inches)
2. Tolerance is ± 0.25 (0.01") unless otherwise noted.
3. Specifications are subject to change without notice.

LED NUMERIC DISPLAY, 2 DIGIT

BL-D50X-21

Typical electrical-optical characteristics curves:



- (1) - GaAsP/GaAs 655nm/Red
- (2) - GaP 570nm/Yellow Green
- (3) - GaAsP/GaP 585nm/Yellow
- (4) - GaAsP/GaP 635nm/Orange & Hi-Eff Red
- (5) - GaP 700nm/Bright Red
- (6) - GaAlAs/GaAs 660nm/Super Red
- (8) - GaAsP/GaP 610nm/Super Red
- (9) - GaAlAs 880nm
- (10) - GaAs/GaAs & GaAlAs/GaAs 940nm
- (A) - GaN/SiC 430nm/Blue
- (B) - InGaN/SiC 470nm/Blue
- (C) - InGaN/SiC 505nm/Ultra Green
- (D) - InGaAlSiC 525nm/Ultra Green

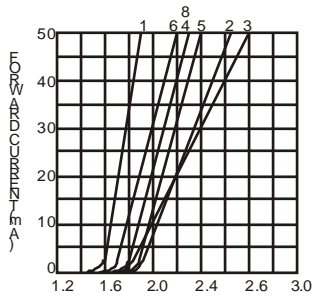

FORWARD VOLTAGE (Vf)
FORWARD CURRENT VS.
FORWARD VOLTAGE



FORWARD CURRENT (mA)
RELATIVE LUMINOUS
INTENSITY VS. FORWARD
CURRENT



AMBIENT TEMPERATURE Ta (°C)
FORWARD CURRENT VS. AMBIENT
TEMPERATURE



AMBIENT TEMPERATURE Ta (°C)



tp-PULSE DURATION μ s
(1,2,3,4,6,8,B,D,J,K)

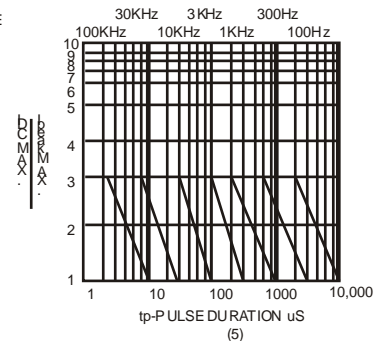

(5)

NOTE: 25 free air temperature unless otherwise specified

LED NUMERIC DISPLAY, 2 DIGIT

BL-D50X-21

Packing and weighting

